

Print-a-page Identifier

Use the 1:1 image and grid scale below to help identify your part. Each grid measures 10mm x 10mm.

The 'Print-a-page Identifier' prints each image at **1:1 scale actual size**. *Note: Use A4 size paper and set your print job to actual size.*



4-2053

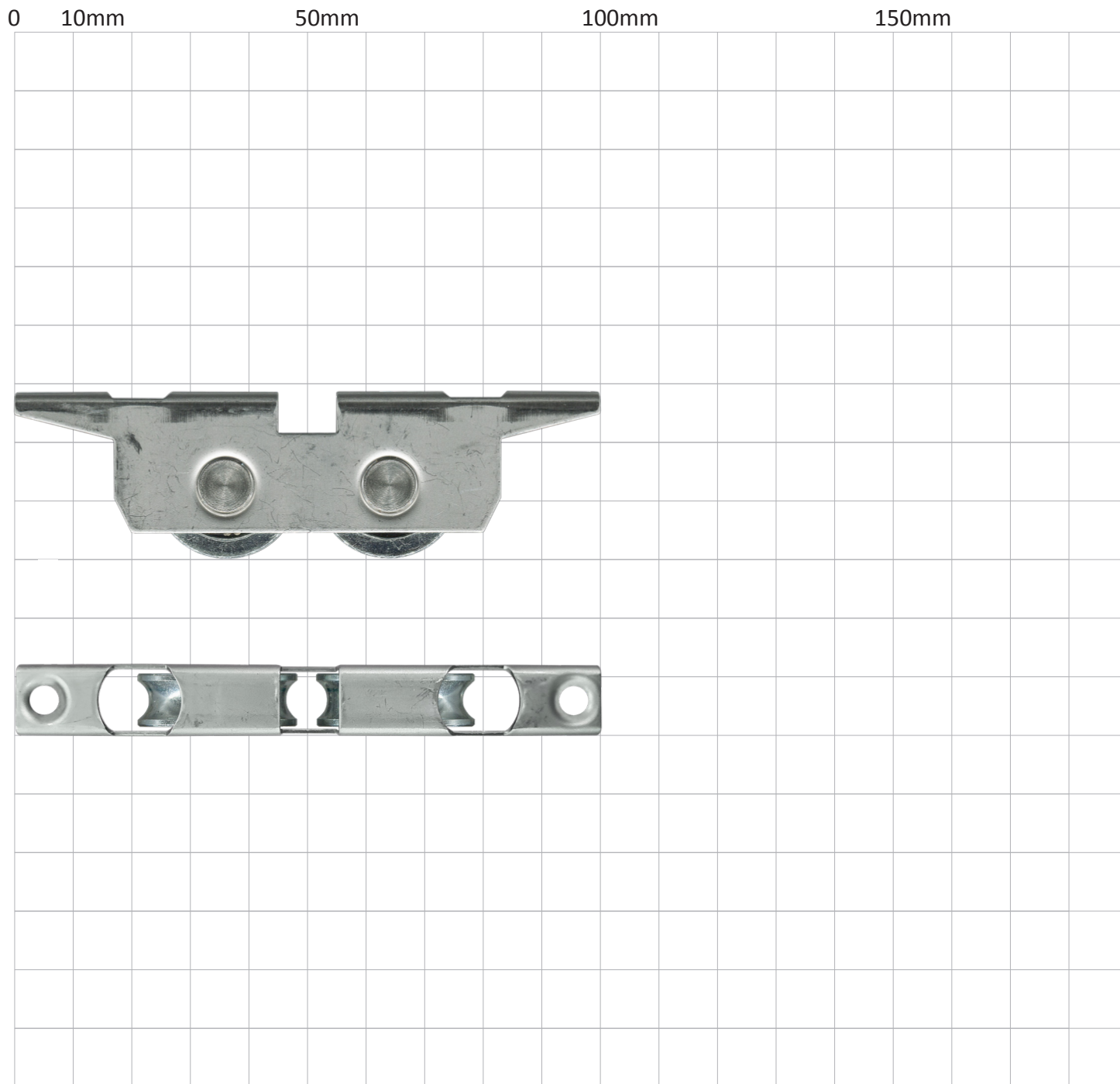

Grid scale is 10mm.

NSW & ACT (03) 9786 0333
salesnsw@total-hardware.com.au

WA (08) 9317 3860
saleswa@total-hardware.com.au

www.total-hardware.com.au

QLD (07) 3255 5034
salesqld@total-hardware.com.au

VIC & TAS (03) 9786 0333
salesvic@total-hardware.com.au

SA & NT (03) 9786 0333
salessa@total-hardware.com.au