

Print-a-page Identifier

Use the 1:1 image and grid scale below to help identify your part. Each grid measures 10mm x 10mm.

The 'Print-a-page Identifier' prints each image at **1:1 scale actual size**. *Note: Use A4 size paper and set your print job to actual size.*

3-3010

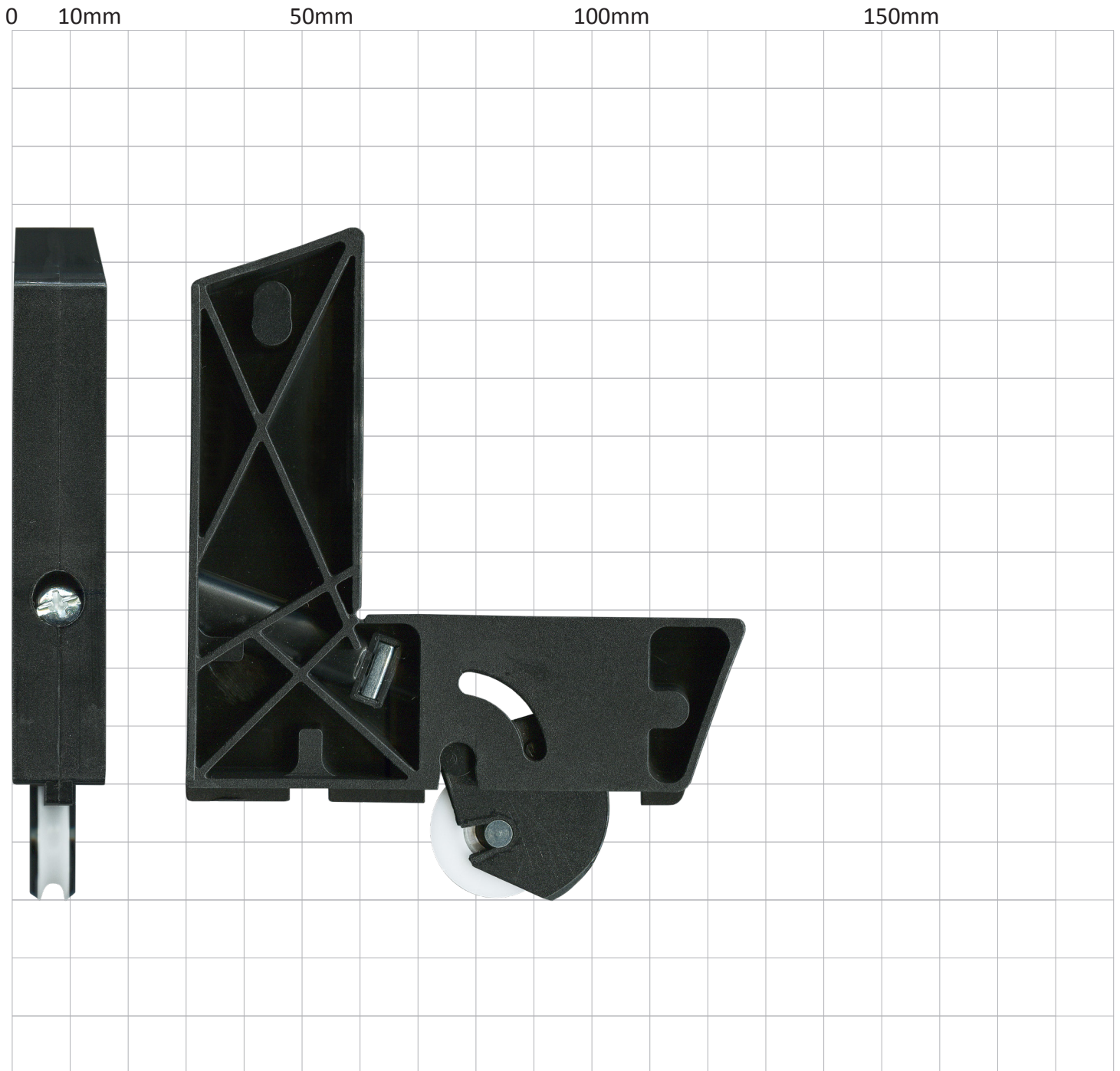

Grid scale is 10mm.